



# COMPONENTES

# S.B.E. - D.T.S.

## S.B.E Modelo 1 Juego Completo

Drip Tray Supports Mod. 1

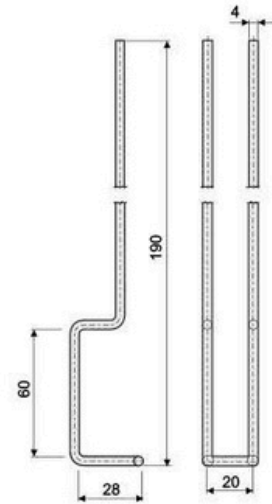
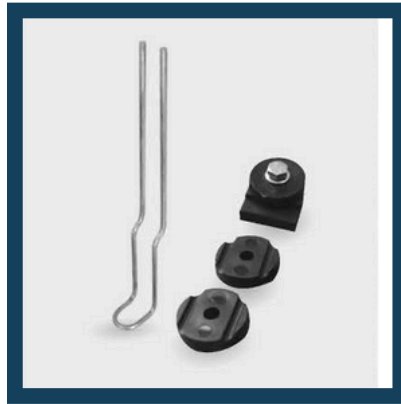

PIEZA	DESCRIP.	PESO	VENTA	COLOR	MATERIALES
120	MODELO 1	88g	UNIDAD	NEGRO Y ALUMINIO	S.B.E= AISI 304 PIEZAS= PA INSERTOS= AISI 304

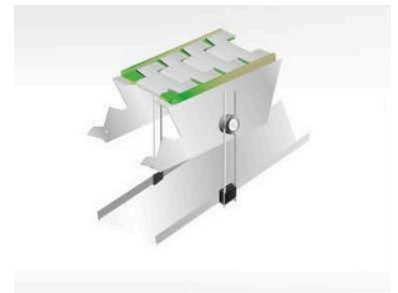

## S.B.E Modelo 2 Juego Completo

Drip Tray Supports Mod. 2

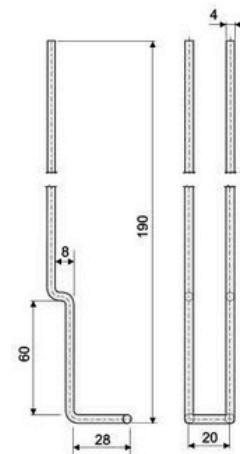
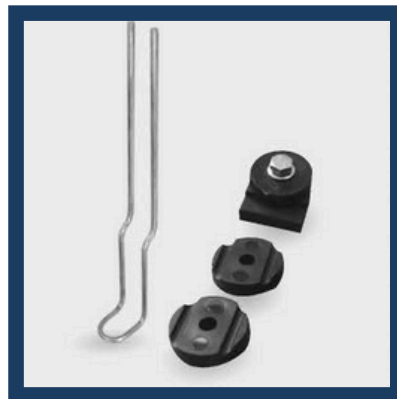

PIEZA	DESCRIP.	PESO	VENTA	COLOR	MATERIALES
121	MODELO 2	65g	UNIDAD	NEGRO Y ALUMINIO	S.B.E.= AISI 304 PIEZAS= PA INSERTOS= AISI 304



# S.B.E. - D.T.S.

## S.B.E Modelo 3-4 Juego Completo

Drip Tray Supports Mod. 3-4 Roler

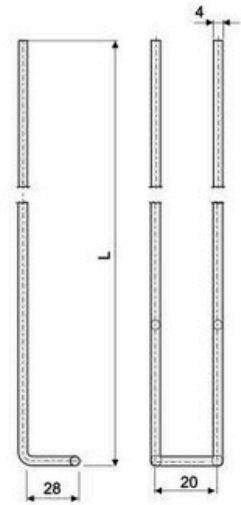
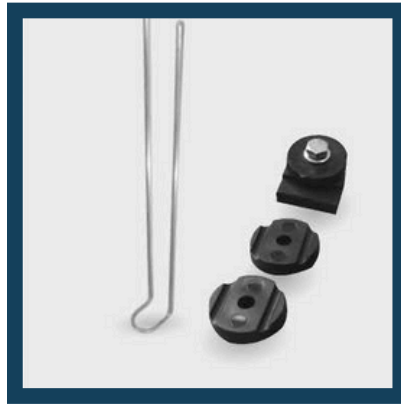

PIEZA	DESCRIP.	PESO	VENTA	COLOR	MATERIALES
122 123	MODELO 3 MODELO 4	74g 77g	UNIDAD	NEGRO Y ALUMINIO	S.B.E= AISI 304 PIEZAS= PA INSERTOS= AISI 304



## S.B.E Modelo 5 Juego Completo

Drip Tray Supports Mod. 5

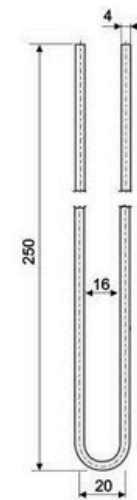
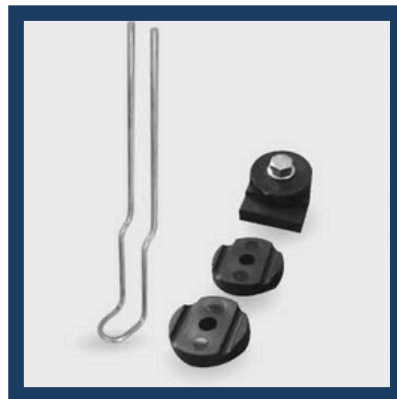

PIEZA	DESCRIP.	PESO	VENTA	COLOR	MATERIALES
313	MODELO 5	75g	UNIDAD	NEGRO Y ALUMINIO	S.B.E.= AISI 304 PIEZAS= PA INSERTOS= AISI 304



# S.B.E. - D.T.S.

## S.B.E Modelo 6 Juego Completo

Drip Tray Supports Mod. 6

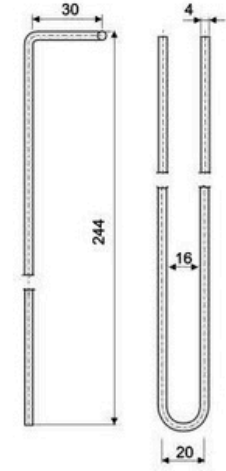

PIEZA	DESCRIP.	PESO	VENTA	COLOR	MATERIALES
310	MODELO 6	75g	UNIDAD	NEGRO Y ALUMINIO	S.B.E= AISI 304 PIEZAS= PA INSERTOS= AISI 304



## S.B.E Piezas Plásticas

Plastic Pieces

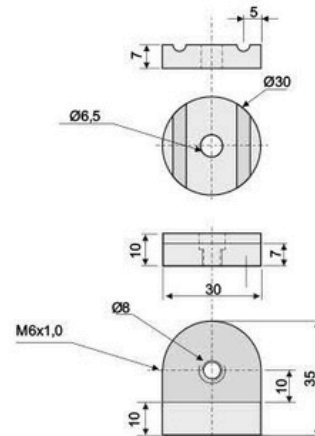

PIEZA	DESCRIP.	PESO	VENTA	COLOR	MATERIALES
067 961 1451	PIEZAS PLÁST. SOLAS (3) PIEZA C/TUERCA INYECT. (1) CONJUNTO COMPLETO	28.8g 11g 50g	UNIDAD	NEGRO Y ALUMINIO	S.B.E.= AISI 304 TORNILLOS= AISI 304





# DONDE ESTAMOS

**MONTEVIDEO 561  
GUAYMALLÉN (5519).  
MENDOZA. ARGENTINA**

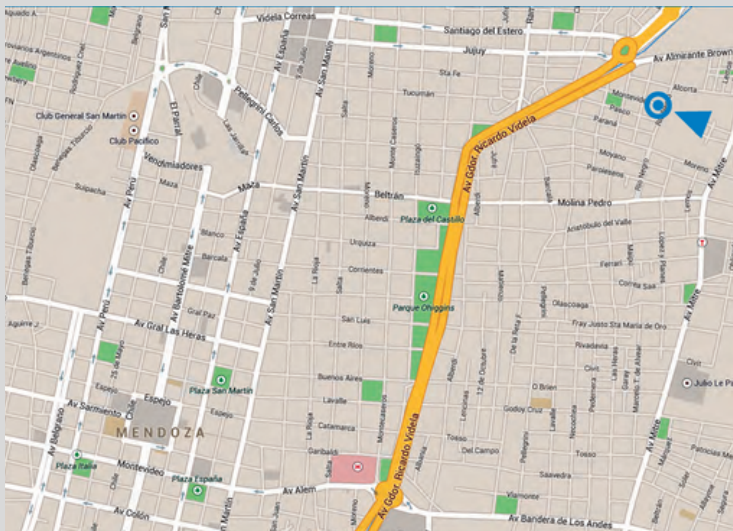

## CONTÁCTANOS

+54 9 261 3878497

[www.surtecnica.ar](http://www.surtecnica.ar)

[infocomercial@surtecnica.com](mailto:infocomercial@surtecnica.com)

[surtecnica](https://www.instagram.com/surtecnica)

